



Jeddah cables
COMPANY

A Company of Energya Cables Saudi Arabia



OVERHEAD LINES



Introduction

Overhead lines are bare conductors that are used for earthing electrical systems (when soft drawn copper is used) and in transmission/distribution of high voltage electricity (when hard drawn copper and aluminum is used). Examples include:

- AAC (All Aluminum Conductors) used in short spans
- AAAC (All -Aluminum -Alloy Conductors)
- ACSR (Aluminium Conductor Steel Reinforced) used in large spans
- ACAR (Aluminium Conductor , Alloy Reinforced)

In this catalogue, we cover all technical aspects of Jeddah Cables Company Overhead Lines. We included Design Considerations such as conductor size, number of wires, and wire diameter. Cables Electrical Parameters such as Conductor DC Resistance are included as well.



Copper Wire (or Aluminum)

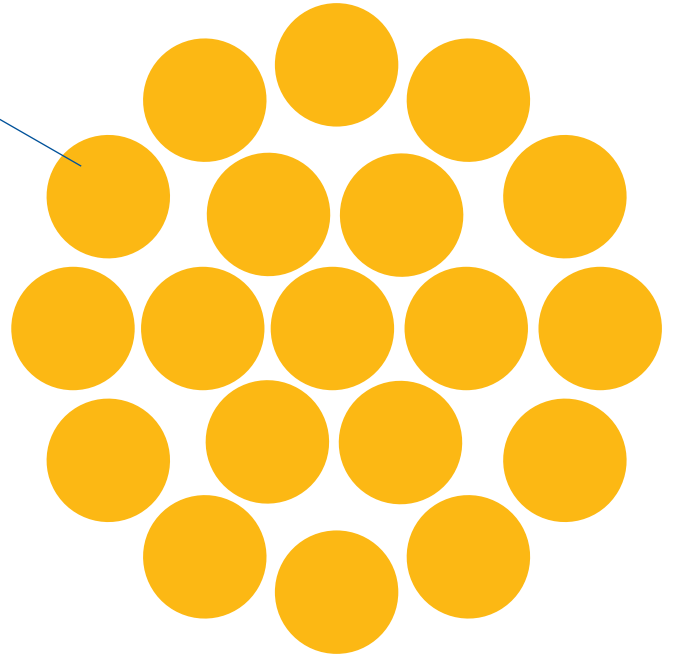

General Information

Standards

- The overhead lines described in this catalogue are all standard types, and their performance has been proved in operation.
- Construction and tests are all in accordance with recommendations of IEC, ASTM, DIN, and BS publications where applicable.
- Overhead lines in accordance to customer requirements and needs can be manufactured upon request.

Variation in Production and Delivery Options

- The provided data is approximate and subject to manufacturing tolerance
- Delivery length tolerance is $\pm 5\%$
- Other overhead line sizes are available upon customer request

Electrical Parameters of Overhead Lines

DC Resistance

- The DC resistance of soft annealed copper conductors is based on 100% conductivity at 20°C with a corresponding resistivity of 0.017241 ohm.mm²/m and a constant mass temperature coefficient at 20°C per Kelvin of 0.00393
- The DC resistance of hard drawn copper conductors is based on 97% conductivity at 20°C with a corresponding resistivity of 0.01771 ohm.mm²/m and a constant mass temperature coefficient at 20°C per Kelvin of 0.00381
- The DC resistance of hard drawn aluminum conductors is based on volume resistivity of 0.028264 ohm.mm²/m and a constant mass temperature coefficient at 20°C per Kelvin of 0.00403°C



Bare Copper Conductors

For grounding electrical systems and equipment

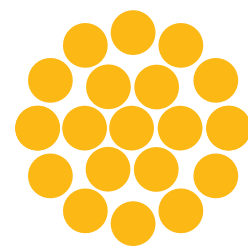

Standard : IEC 60228
Conductor : Soft annealed stranded copper wires
Packing : Coils or Non returnable wooden drums as per customer requirements



TECHNICAL INFORMATION

Nominal Cross Section	Number & nominal wire diameter	Approx. Overall diameter	Approx. Conductor weight	Max DC Resistance at 20°C
mm ²	NR x mm	mm	Kg/km	ohm/km
4	7x0.84	2.5	35	4.610
6	7x1.03	3.1	50	3.080
10	7x1.33	4.0	90	1.830
16	7x1.617	5.0	140	1.150
25	7x2.11	6.3	220	0.727
35	7x2.48	7.44	300	0.524
50	19x1.76	8.8	415	0.387
70	19x2.12	10.55	595	0.268
95	19x2.48	12.4	820	0.193
120	37x2.00	14.14	1060	0.153
150	37x2.22	15.6	1290	0.124
185	37x2.48	17.36	1600	0.0991
240	61x2.22	20.0	2130	0.0754
300	61x2.48	22.32	2645	0.0601
400	61x2.82	25.4	3455	0.0470
500	61x3.17	28.6	4365	0.0366

Bare Copper Conductors

For transmission and distribution in electrical networks

Standard : DIN 48201-Part 1
Conductor : Hard drawn stranded copper wires
Packing : Non returnable wooden drums as per customer requirements

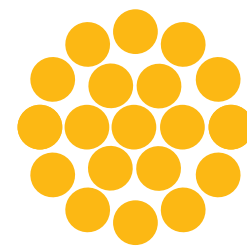

TECHNICAL INFORMATION

Nominal Cross Section	Number & nominal wire diameter	Approx. Overall diameter	Approx. Conductor weight	Max DC Resistance at 20°C	Calculated Breaking Load
mm ²	NR x mm	mm	Kg/km	ohm/km	KN
10	7x1.35	4.05	90	1.8060	4.1
16	7x1.70	5.1	145	1.1385	6.5
25	7x2.10	6.3	220	0.7461	9.9
35	7x2.50	7.5	310	0.5264	14.0
50	19x1.80	9.0	435	0.3759	19.8
70	19x2.10	10.5	595	0.2762	26.9
95	19x2.50	12.5	845	0.1949	38.1
120	19x2.80	14.0	1065	0.1554	47.8
150	37x2.25	15.7	1335	0.1238	60.1
185	37x2.50	17.5	1650	0.1003	74.2
240	61x2.25	20.2	2210	0.0753	99.0
300	61x2.50	22.5	2725	0.0610	122.3
400	61x2.89	26.0	3640	0.0456	163.4
500	61x3.23	29.1	4545	0.0365	204.2

All Aluminum Conductors (AAC)

For transmission and distribution in electrical networks with relatively short spans

Standard : DIN 48201- Part 5, BS 215
 Conductor : Hard drawn stranded aluminum wires
 Packing : Non returnable wooden drums as per customer requirements

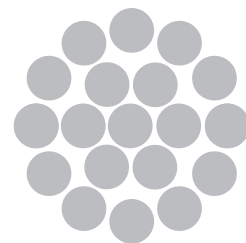

TECHNICAL INFORMATION

A-According To DIN 48201

Nominal Cross Section	Number & nominal wire diameter	Approx. Overall diameter	Approx. Conductor weight	Max DC Resistance at 20°C	Calculated Breaking Load
mm ²	NR x mm	mm	Kg/km	ohm/km	KN
16	7x1.70	5.1	45	1.8017	2.84
25	7x2.10	6.3	65	1.1807	4.17
35	7x2.50	7.5	95	0.8331	5.78
50	7x3.00	9.0	135	0.5786	7.94
50	19x1.80	9.0	135	0.5949	8.45
70	19x2.10	10.5	180	0.4371	11.32
95	19x2.50	12.5	255	0.3084	15.68
120	19x2.80	14.0	320	0.2459	18.78
150	37x2.25	15.7	405	0.1960	25.30
185	37x2.50	17.5	500	0.1587	30.54
240	61x2.25	20.2	670	0.1191	39.51
300	61x2.50	22.5	825	0.09649	47.70
400	61x2.89	26.0	1105	0.07220	60.86
500	61x3.23	29.1	1380	0.05781	74.67
630	91x2.96	32.6	1730	0.04625	95.25

B-According To BS 215

Code Name	Nominal Cross Section	Number & nominal wire diameter	Approx. Overall diameter	Approx. Conductor weight	Max DC Resistance at 20°C	Calculated Breaking Load
Name	mm ²	NR x mm	mm	Kg/km	ohm/km	KN
MIDGE	22	7X2.06	6.18	64	1.227	3.99
ANT	50	7X3.10	9.30	145	0.5419	8.28
FLY	60	7X3.40	10.2	174	0.4505	9.90
WASP	100	7X4.39	13.17	290	0.2702	16.0
HORNET	150	19X3.25	16.25	434	0.1825	25.7
CHAFER	200	19X3.78	18.9	587	0.1349	32.4
COCKROACH	250	19X4.22	21.1	731	0.1083	40.0
BUTTERFLY	300	19X4.65	23.25	888	0.08916	48.75
CENTIPEDE	400	19X3.78	26.46	1145	0.06944	56.10

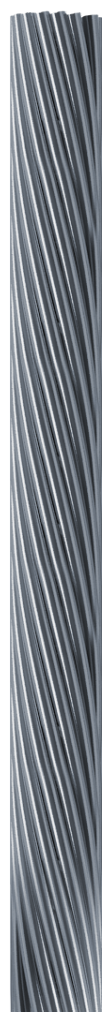

Aluminum Conductors Steel Reinforced (ACSR)

For transmission and distribution in electrical networks over long spans

Standard : ASTM B 232

Conductor : A center galvanized steel wire(s) and Hard drawn stranded aluminum wires*

Packing : Non returnable wooden drums as per customer requirements

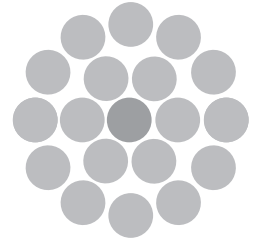

TECHNICAL INFORMATION

Code Name	Nominal Cross Section	Number & nominal wire diameter N*d (mm)		Approx. Overall diameter	Approx. Conductor weight Kg/km		Max DC Resistance at 20°C	Calculated Breaking Load
		Al	Steel		mm	Al		
Name	mm ²			mm			ohm/km	KN
GROUSE	40.5	8*2.54	1*4.24	9.3	110	110	0.7112	23.1
PETREL	51.6	12*2.34	7*2.34	11.7	140	235	0.5614	46.2
MINORCA	56.1	12*2.44	7*2.44	12.2	155	255	0.5163	50.2
LEGHORN	68.2	12*2.69	7*2.69	13.45	190	310	0.4248	60.5
GUINEA	80.4	12*2.92	7*2.92	14.6	225	370	0.3605	71.1
DOTTEREL	89.4	12*3.08	7*3.08	15.4	250	410	0.3240	76.9
DORKING	96.5	12*3.20	7*3.20	16	265	445	0.3002	83.1
BRAHMA	102.8	16*2.86	19*2.48	18.1	285	720	0.2819	126.3
COCHIN	107.1	12*3.37	7*3.37	16.9	300	490	0.2707	92.0
TURKEY	13.3	6*1.70	1*1.70	5.0	35	15	2.157	5.3
SWAN	21.2	6*2.12	1*2.12	6.36	60	25	1.3545	8.3
SWANATE	21.1	7*1.96	1*2.61	6.5	60	45	1.3583	10.5
SPARROW	33.6	6*2.67	1*2.67	8.0	90	45	0.8540	12.7
SPARATE	33.5	7*2.47	1*3.30	8.3	90	70	0.8553	16.1
ROBIN	42.4	6*3.00	1*3.00	9.0	115	55	0.6764	15.8
RAVEN	53.5	6*3.37	1*3.37	10.1	150	70	0.5360	19.4
QUAIL	67.4	6*3.78	1*3.78	11.4	190	90	0.4261	23.6
PIGEON	85.1	6*4.25	1*4.25	12.7	235	110	0.337	29.4
PENGUIN	107.2	6*4.77	1*4.77	14.3	295	140	0.2676	37.1
WAXWING	135.0	18*3.09	1*3.09	15.5	375	60	0.2136	30.3
PARTIRIDGE	134.9	26*2.57	7*2.0	16.3	374	175	0.2148	50.2
OSTRICH	152.2	26*2.73	7*2.12	17.3	420	195	0.1904	56.6
MERLIN	170.2	18*3.47	1*3.47	17.4	470	75	0.1694	38.2
LINNET	170.6	26*2.89	7*2.25	18.3	475	215	0.1699	62.8
ORIOLE	170.5	30*2.69	7*2.69	18.8	475	315	0.1703	77.4
CHICKADDEE	200.9	18*3.77	1*3.77	18.9	545	85	0.1435	44.3
BRANT	201.6	24*3.27	7*2.18	19.6	560	205	0.1437	64.7
IBIS	201.3	26*3.14	7*2.44	19.8	560	255	0.1439	72.1
LARK	200.9	30*2.92	7*2.92	20.5	560	370	0.1446	90.3
PELICAN	241.70	18*4.14	1*4.14	20.7	657	105	0.1190	52.3
FLICKLER	241.6	24*3.58	7*2.39	21.5	670	245	0.1199	76.8
HAWK	241.7	26*3.44	7*2.67	21.8	670	310	0.1199	86.4
HEN	241.3	30*3.20	7*3.20	22.4	670	440	0.1204	105.2
OSPREY	282.5	18*4.47	1*4.47	22.3	780	125	0.1021	61.0
PARAKEET	282.3	24*3.87	7*2.58	23.2	785	285	0.1026	88.3
DOVE	282.6	26*3.72	7*2.89	23.5	780	360	0.1025	101.1



* Grease may be applied for anti-corrosive purposes if required.

Aluminum Conductors Steel Reinforced (ACSR)

TECHNICAL INFORMATION

Code Name	Nominal Cross Section	Number & nominal wire diameter N*d (mm)		Approx. Overall diameter	Approx. Conductor weight Kg/km		Max DC Resistance at 20°C	Calculated Breaking Load
		Al	Steel		Al	Steel		
Name	mm ²			mm			ohm/km	KN
EAGLE	282.6	30*3.45	7*3.45	24.15	775	511	0.1030	1229
PEACOCK	306.1	24*4.03	7*2.69	24.2	850	310	0.0946	95.9
SWAB	305.8	26*3.87	7*3.01	24.5	850	390	0.0947	108.1
WOODDUCK	307.1	30*3.61	7*3.61	25.3	850	660	0.0946	129.0
TEAL	307.1	30*3.61	19*2.16	25.21	850	550	0.0946	133.4
SWIFT	323.0	36*3.38	1*3.38	23.7	890	70	0.0893	60.7
KINGBIRD	323.0	18*4.78	1*4.78	23.9	890	140	0.0893	69.7
ROOK	323.1	24*4.14	7*2.76	24.8	895	325	0.0897	101.0
GROSSBEAK	322.7	26*3.97	7*3.09	25.12	895	410	0.0900	111.9
SCOTER	322.7	30*3.70	7*3.70	25.9	895	600	0.0900	135.5
EGRET	322.6	30*3.70	19*2.22	25.9	895	575	0.0900	140.6
FLAMINGO	337.3	24*4.23	7*2.82	25.4	935	345	0.859	105.5
GANNET	338.3	26*4.07	7*3.16	25.8	935	430	0.0857	117.3
STILT	363.3	24*4.39	7*2.92	26.3	1005	370	0.0798	113.3
STARLING	361.9	26*4.21	7*3.28	26.68	1005	460	0.0800	126.0
REDWING	362.1	30*3.92	19*2.35	27.5	1005	645	0.0802	153.7
CUCKOO	402.8	24*4.62	7*3.08	27.72	1115	440	0.0720	123.8
DRAKE	402.6	26*4.44	7*3.45	28.11	1115	510	0.0720	139.7
TERN	402.8	45*3.38	7*2.25	27.03	1120	220	0.0718	97.5
COOT	401.9	36*3.77	1*3.77	26.4	1110	90	0.0717	74.7
CONDOR	402.8	54*3.08	7*3.08	27.72	1116	410	0.0720	124.3
MALLARD	403.8	30*4.14	19*2.48	29.0	1120	720	0.0719	171.2
RUDDY	455.5	45*3.59	7*2.40	28.7	1265	245	0.0636	109.4
CANARY	456.4	54*3.28	7*3.28	29.52	1265	460	0.0635	141.0
RAIL	483.4	45*3.70	7*2.47	29.61	1340	260	0.0599	116.1
CATIBIRD	484.6	36*4.14	1*4.14	29.0	1335	105	0.0595	87.9
CARDINAL	484.5	54*3.38	7*3.38	30.4	1340	490	0.0598	149.7
ORTOLAN	523.9	45*3.85	7*2.57	30.8	1450	285	0.0553	123.3
TANAGER	522.8	36*4.30	1*4.30	30.1	1445	115	0.0551	94.8
CURLEW	522.5	54*3.51	7*3.51	31.59	1440	530	0.0554	161.5
BLUEJAY	564.0	45*4.00	7*2.66	32.0	1565	305	0.0512	132.7
FINCH	565.0	54*3.65	19*2.19	32.8	1570	560	0.0515	174.6
BUNTING	605.8	45*4.14	7*2.76	33.1	1675	325	0.0478	142.4
GRACKLE	602.8	54*3.77	19*2.27	34.0	1680	600	0.0483	186.9
BITTERN	644.4	45*4.27	7*2.85	43.2	1785	350	0.0450	151.6
PHEASANT	645.1	54*3.90	19*2.34	35.1	1785	640	0.0451	194.1
SKYLARK	643.3	36*4.77	1*4.77	33.4	1775	140	0.0448	116.7
DIPPER	684.2	45*4.40	7*2.93	35.2	1895	370	0.0423	160.7
MARTIN	685.4	54*4.02	19*2.41	36.2	1905	680	0.0425	206.1
BOBOLINK	725.2	45*4.53	7*3.02	36.3	2010	390	0.0399	170.5
PLOVER	726.9	54*4.14	19*2.48	37.2	2020	720	0.0401	218.4
NUTHATCH	746.2	45*4.65	7*3.10	37.2	2120	415	0.0379	177.6
PARROT	766.1	54*4.25	19*2.55	38.2	2130	760	0.0380	230.5
LAPWING	807.5	45*4.78	7*3.18	38.2	2230	435	0.0359	187.4
FALCON	806.2	54*4.36	19*2.62	39.2	2240	800	0.0361	243.0

PVC Insulated Hard Drawn Copper Conductors

For overhead power lines when crossing telecommunication Lines

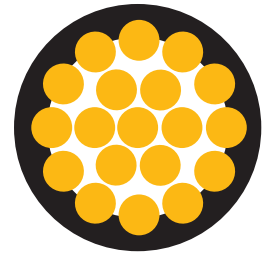

Type : Type 8 (or Type 16)*
Standard : BS 6485
Conductor : Hard drawn stranded copper wires
Insulation : PVC compound**
Packing : Non returnable wooden drums as per customer requirements

TECHNICAL INFORMATION

Type 8

Nominal Cross Section	Number & nominal wire diameter	Minimum insulation Thickness	Approx. Overall diameter	Approx. Conductor weight	Max DC Resistance at 20°C
mm ²	NR x mm	mm	mm	Kg/km	ohm/km
10	7x1.35	0.8	6.05	115	1.890
16	7x1.70	0.8	7.1	180	1.190
25	7x2.14	0.8	8.42	265	0.749
35	7x2.50	0.8	9.5	355	0.540
50	7x3.0	0.8	11	515	0.399
50	19x1.80	0.8	11.0	505	0.399
70	19x2.10	0.8	12.5	565	0.276
95	19x2.50	0.8	14.5	950	0.199
120	19x2.50	0.8	16.0	1180	0.158
150	37x2.25	0.8	17.8	1460	0.128
185	37x2.50	0.8	19.5	1790	0.102



*Insulation color is black for Type 8, green for Type 16, or other colors as per customer requirements

**Type 16 (increased insulation thickness) overhead lines are available.

PVC Insulated Hard Drawn Aluminum Conductors

For overhead power lines when crossing telecommunication Lines

Type : Type 8 (or Type 16)*
 Standard : BS 6485
 Conductor : Hard drawn stranded copper wires
 Insulation : PVC compound**
 Packing : Non returnable wooden drums as per customer requirements

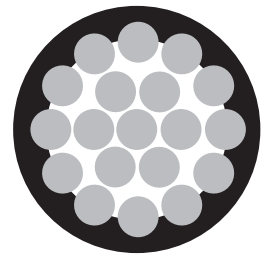

TECHNICAL INFORMATION

Nominal Cross Section	Number & nominal wire diameter	Minimum insulation Thickness	Approx Overall diameter	Approx Conductor weight	Max DC Resistance at 20°C
mm ²	NR x mm	mm	mm	Kg/km	ohm/km
16	7x1.70	0.8	7.1	80	1.8017
25	7x2.10	0.8	8.3	115	1.1807
35	7x2.50	0.8	9.5	145	1.8331
50	7x3.10	0.8	11.3	195	0.5786
50	19x1.80	0.8	11.0	200	0.5949
70	19x2.10	0.8	12.5	250	0.4371
95	19x2.50	0.8	14.5	335	0.3084
120	19x2.80	0.8	16.0	415	0.2459
150	37x2.25	0.8	17.75	512	0.1960
185	37x2.50	0.8	19.5	605	0.1587



*Insulation color is black for Type 8, green for Type 16, or other colors as per customer requirements

**Type 16 (increased insulation thickness) overhead lines are available.

Conversion Table

Multiply by to obtain			Multiply by to obtain		
WEIGHT - Imperial			LENGTH - Imperial		
Ounces _____	28.3495	grams	Mils _____	0.001	inches
Pounds (Av) _____	453.59	grams	Mils _____	0.0254	millimeters
Pounds (Av) _____	0.45359	kilograms	Inches _____	1000	mils
Tons (short) _____	907.19	kilograms	Inches _____	25.40	millimeters
Tons (long) _____	1016.05	kilograms	Inches _____	2.54	centimeters
WEIGHT - Metric			LENGTH - Imperial		
Grams _____	0.03527	ounces	Feet _____	30.48	centimeters
Grams _____	0.002205	pounds	Feet _____	0.3048	meters
Kilograms _____	35.274	ounces	Feet (thousands of) _____	0.3048	kilometers
Kilograms _____	2.2046	pounds	Yards _____	0.9144	meters
Kilograms _____	0.001102	tons (short)	Mils _____	1.6093	kilometers
Kilograms _____	0.0009842	tons (long)	LENGTH - Imperial		
MISCELLANEOUS - Imperial			LENGTH - Imperial		
Pounds per 1000 feet _____	1.48816	kilograms per kilometer	Millimeters _____	39.37	mils
Pounds per mile _____	0.28185	kilograms per kilometer	Millimeters _____	0.03937	inches
Pounds per square inch _____	0.0007031	kilograms per square millimeter	Centimeters _____	0.3937	inches
Pounds per square inch _____	0.07031	kilograms per square centimeter	Centimeters _____	0.032808	feet
Feet per second _____	18.288	meters per minute	Meters _____	39.37	inches
Feet per second _____	1.09728	kilometers per hour	Meters _____	3.2808	feet
Mils per hour _____	1.60935	kilometers per hour	Meters _____	1.0936	yards
Ohms per 1000 feet _____	3.28083	ohms per kilometer	Kilometers _____	3280.83	feet
Ohms per mile _____	0.62137	ohms per kilometer	Kilometers _____	0.62137	mils
Decibels per 1000 feet _____	3.28083	decibels per kilometer	AREA - Imperial		
Decibels per mile _____	0.62137	decibels per kilometer	Square mils _____	1.2732	circular mills
Decibels _____	0.1153	nepers	Square mils _____	0.000001	square inches
MISCELLANEOUS - Metric			AREA - Imperial		
Kilograms per kilometer _____	0.67197	pounds per 1000 feet	Circular mils _____	0.7854	square mils
Kilograms per kilometer _____	3.54795	pounds per mile	Circular mils _____	0.0000007854	square inches
Kilograms per square millimeter _____	1422.34	pounds per square inch	Circular mils _____	0.00050657	square millimeters
Kilograms per square centimeter _____	14.2234	pounds per square inch	Square inches _____	1000000	square mils
Grams per cubic cm _____	0.03613	pounds per cubic inch	Square inches _____	1273240	circular mils
Meters per minute _____	0.05468	feet per second	Square inches _____	645.16	square millimeters
Kilometer per hour _____	0.91134	feet per second	Square inches _____	6.4516	square centimeters
Kilometer per hour _____	0.62137	miles per hour	Square inches _____	0.09290	square meters
Ohms per kilometer _____	0.3048	ohms per 1000 feet	Square inches _____	0.8361	square meters
Ohms per kilometer _____	1.6093	ohms per mile	AREA - Metric		
Decibels per kilometer _____	0.3048	decibels per 1000 feet	Square millimeters _____	1973.52	circular mills
Decibels per kilometer _____	1.6093	decibels per mile	Square millimeters _____	0.00155	square inches
TEMPERATURE			VOLUME - Imperial		
°Fahrenheit _____	5/9 (°F)-32	°Celsius	Square centimeters _____	0.155	square inches
°Celsius _____	9/5 (°C) + 32	°Fahrenheit	Square meters _____	10.7638	square feet
			VOLUME - Imperial		
			VOLUME - U.S.		
			VOLUME - Metric		
			Cubic inches _____	16.38716	cubic centimeters
			Cubic feet _____	0.028317	cubic meters
			Quarts (liquid) _____	0.9463	cubic centimeters
			Gallons _____	3.7854	cubic meters
			Cubic centimeters _____	0.06102	cubic inches
			Cubic meters _____	35.3145	cubic feet
			Litres _____	1.05668	quarts (Liquid U.S.)
			Litres _____	0.26417	gallons

Packing

International practice is to supply cables on wooden drums or as appropriate plastic spools. At the customer's request we will also supply steel drums for improved on-site performance & handling.

The finished drums may be - when requested by our customer - closed with a continuous lagging with a wood having approximate thickness 2.00 mm.

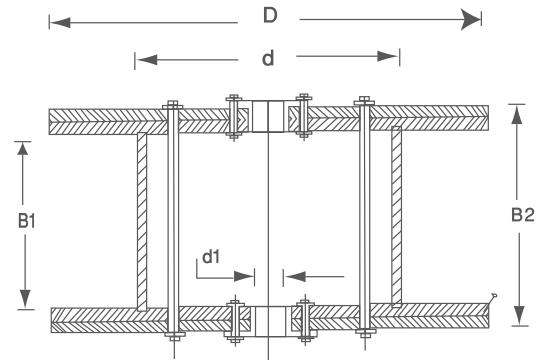

Drum Dimensions:

D	d	d1	B1	B2
600	300	85	450	580
700	350	85	530	660
800	400	85	530	660
900	450	85	630	760
1000	500	85	630	772
1100	550	85	630	772
1200	600	85	850	992
1300	650	85	850	992
1400	700	85	850	992
1500	750	110	850	1020
1600	800	110	850	1020
1700	850	110	850	1020
1800	900	110	850	1032
1900	950	110	850	1032
2000	1000	110	980	1174
2100	1050	110	980	1174
2200	1100	110	1230	1274
2300	1150	110	1280	1432
2400	1200	110	1280	1482
2500	1250	110	1280	1482
2600	1300	110	1280	1432
2700	1350	110	1280	1482
2800	1400	110	1280	1482
2900	1450	110	1280	1482
3000	1500	110	1280	1482

LEGEND

D	=	Flange Diameter	(mm)
d	=	Barrel Diameter	(mm)
d1	=	Benz hole diameter	(mm)
B1	=	Distance between flanges	(mm)
B2	=	Overall Width	(mm)

Selection form: Overhead Lines

This form needs to be filled in order to help Jeddah Cables Company prepare the night quotation

Standard & Specification

- IEC
- BS
- ASTM
- Others _____

Cu Conductor

- Size (mm² , AWG or kcmil) _____
- Code name _____
- Conductor Type
 - Bare Soft Copper
 - Bare Hard Copper
 - AAC (All Aluminum Conductor)
 - ACSR (All Aluminum Conductor Steel Reinforced)
 - ACSR / AW (All Aluminum Conductor Aluminum Clad Steel Reinforced)
 - PVC Insulated Hard Drawn Copper
 - Type 8
 - Type 16
 - PVC Insulated Hard Drawn Aluminum
 - Type 8
 - Type 16

Special Requirements _____

P.O. Box 31248 Jeddah 21497, Kingdom of Saudi Arabia
Tel. + 966 2 636 0770 • Fax: +966 2 636 4695
Email: info@cables.energya.com • web: <http://www.cables.energya.com>